

# Mini-Din Plugs

171-2603, 171-2604, 171-2605,  
171-2606, 171-2608, 171-2609

**KOBI** CONN

Mini-Din Plugs

171-2603, 171-2604, 171-2605, 171-2606, 171-2608, 171-2609

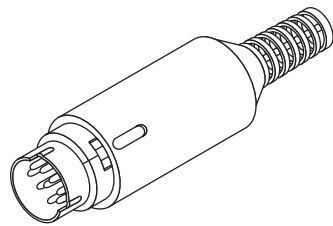
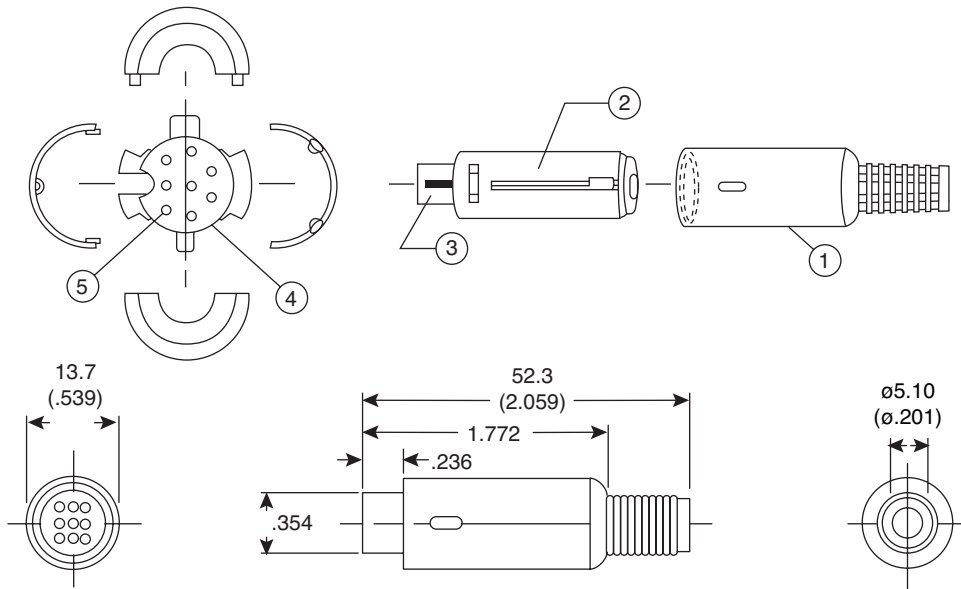

Dimensions: mm (IN.)

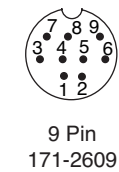
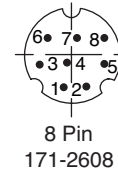
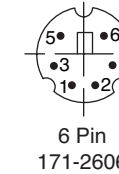
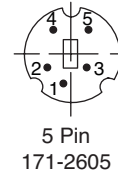
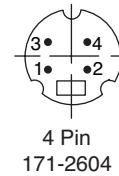
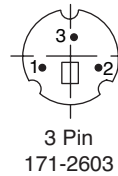

SPECIFICATIONS	
<b>Voltage Rating:</b>	100VAC 1A max.
<b>Insulation Resistance:</b>	50MΩ @ 500VDC
<b>Dielectric:</b>	500VAC for 1 minute
<b>Contact Resistance:</b>	30m Ω max.
<b>Maximum Acceptable Wire Size:</b>	16AWG
<b>Boot:</b>	PVC
<b>Housing:</b>	ABS
<b>Shell:</b>	nickel plated bronze
<b>Insulator:</b>	polycarbonate
<b>Pins:</b>	silver plated bronze
<b>Assembly:</b>	yes

ASSEMBLY SPECIFICATIONS		
1	<b>Cover:</b>	PVC black
2	<b>Con:</b>	A.B.S.
3	<b>Shell:</b>	bronze, nickel plated
4	<b>Insulator:</b>	PC (or nylon)
5	<b>Pin:</b>	bronze

Date Last Revised: 10-18-05

Available from Mouser Electronics  
1-800-346-6873  
www.mouser.com

KC- 300256